

El incumplimiento de estas instrucciones exime de toda responsabilidad a TRES Grifería.  
TRES Grifería décline toute responsabilité en cas d'inobservance de ces instructions.  
Bei Nichtbefolgung der Bedienungsanleitung übernimmt TRES Grifería keinerlei Haftung.  
Het niet opvolgen van deze instructies ontslaat TRES Grifería van alle aansprakelijkheid.  
L'inadempimento di queste istruzioni esonera TRES Grifería da ogni responsabilità.  
Nedodržení pokynů v návodu zbavuje společnost TRES Grifería veškeré zodpovědnosti.  
Any failure to follow these instructions releases TRES Grifería from any liability.  
Niezasztosowanie się do instrukcji zwalnia z wszelkiej odpowiedzialności TRES Grifería.

# TRES

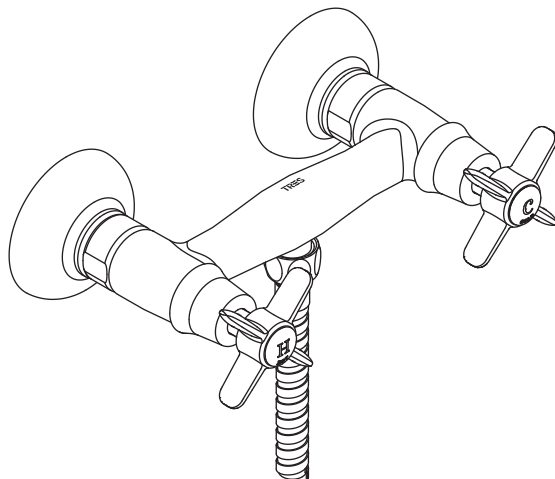

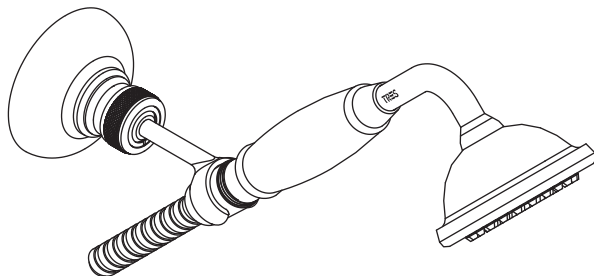
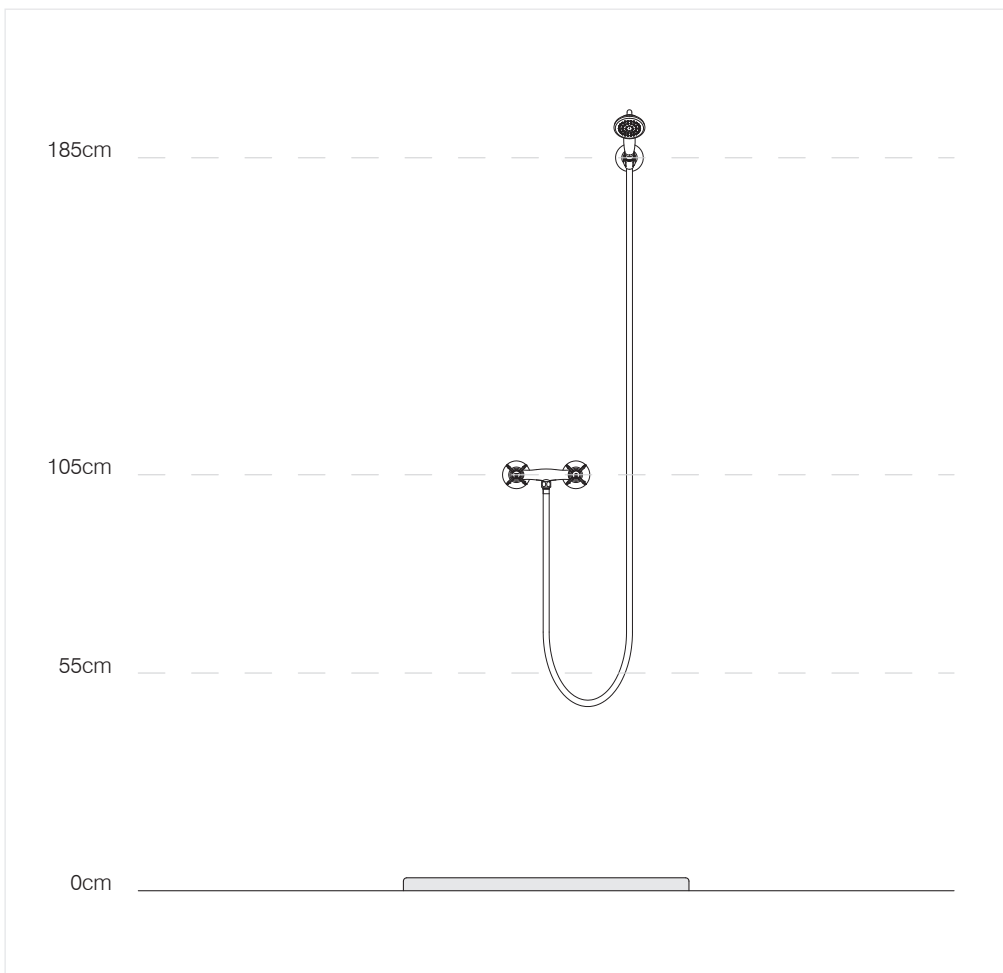
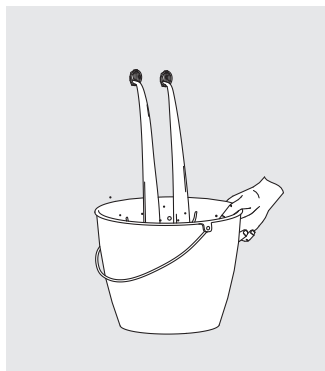
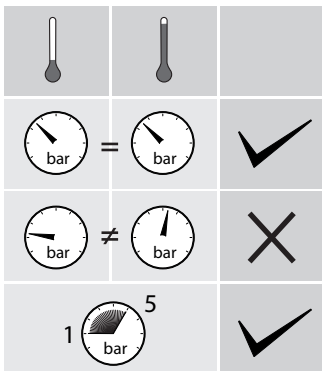
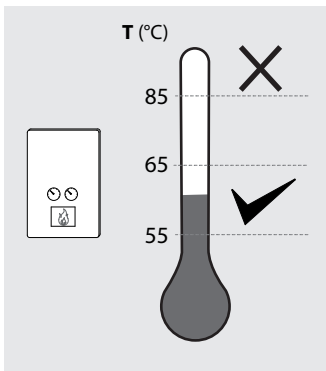

1

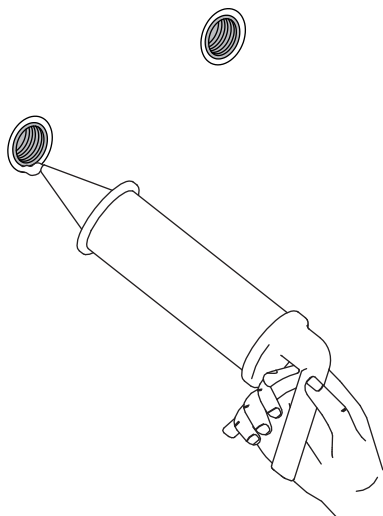

2

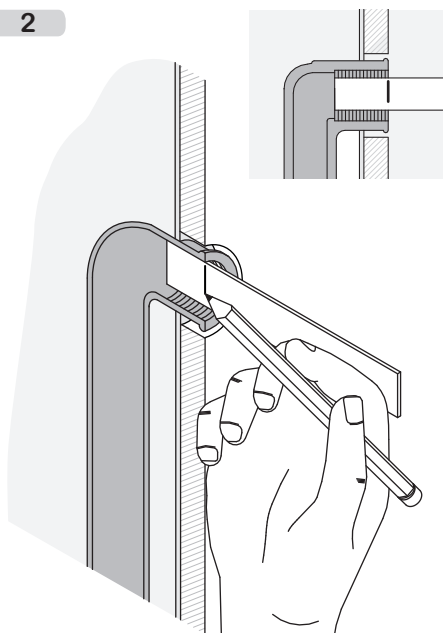

3

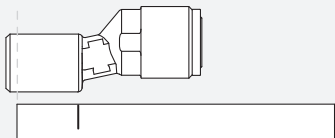
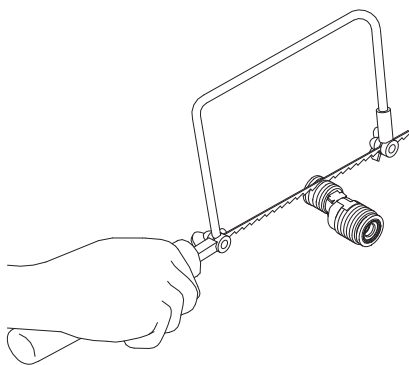

4

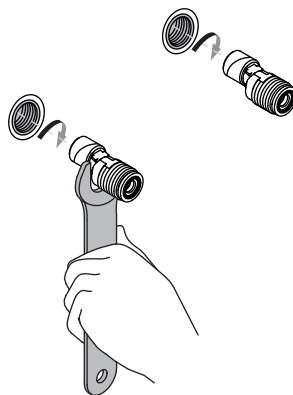

5

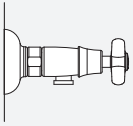
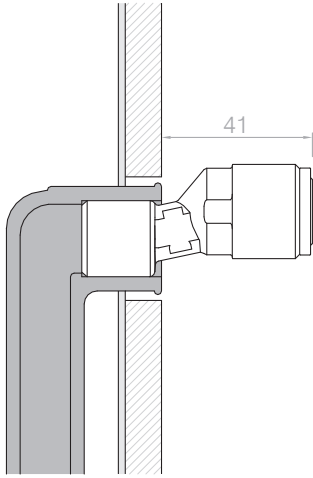

6

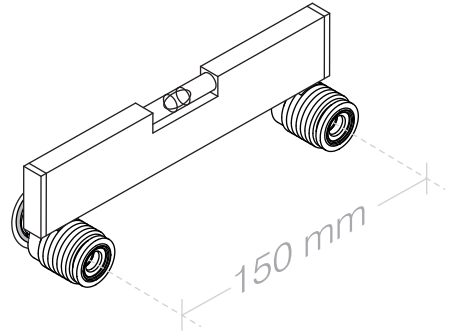

7

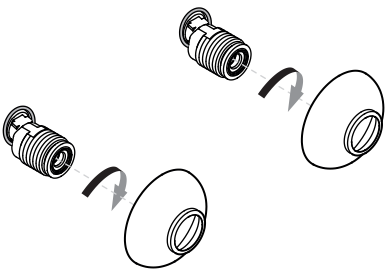

8

30

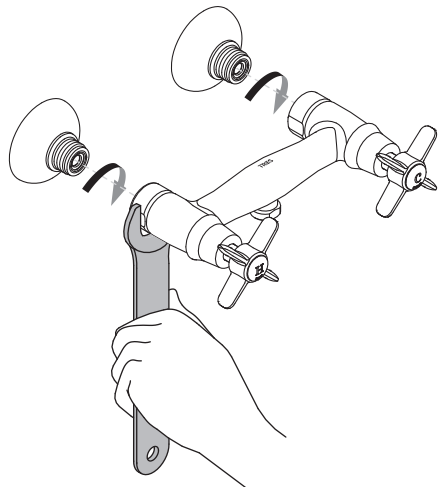

9

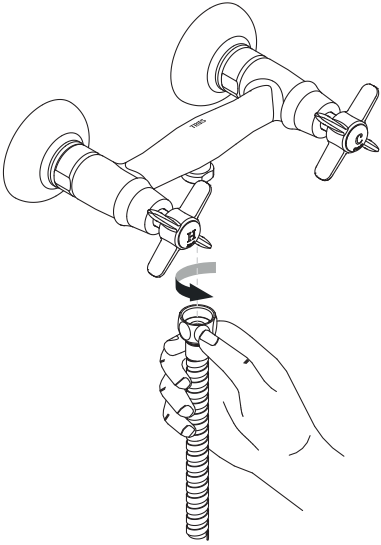

10

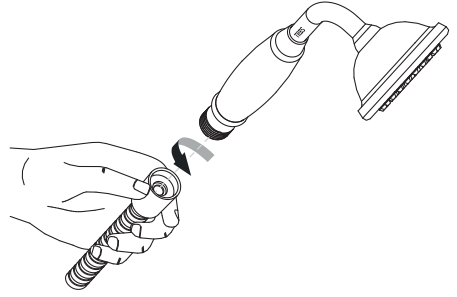

11

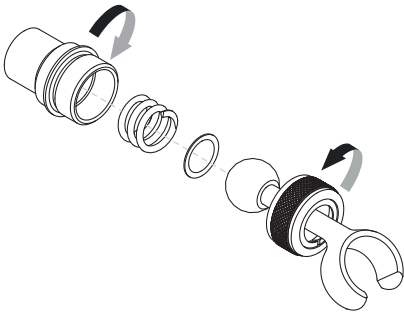

12

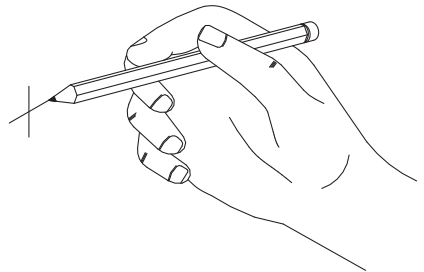

13

Ø8

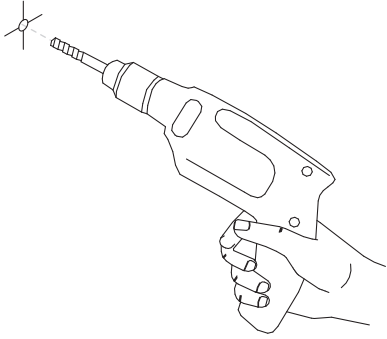

14

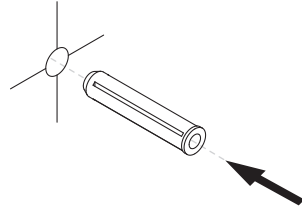

15

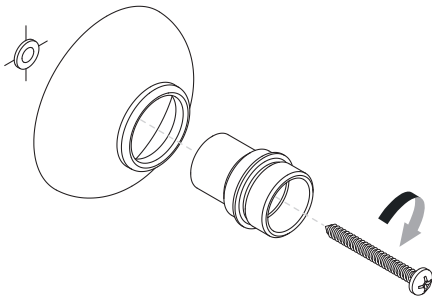

16

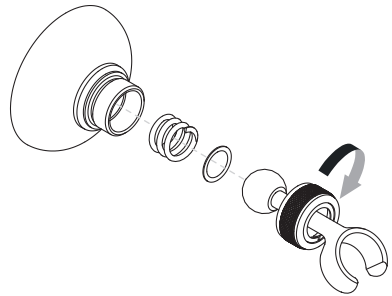

17A

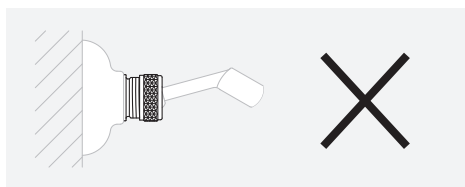
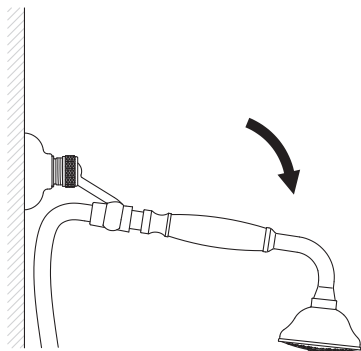

17B

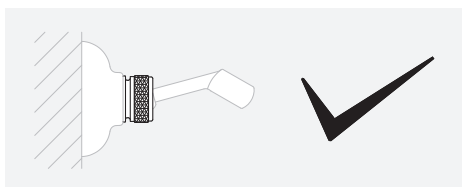
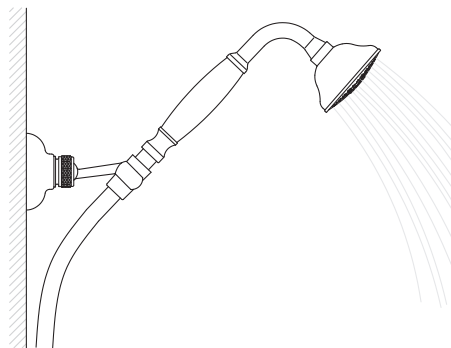

ACCESO A LA MONTURA • ACCÈS À LA MONTURE • ZUGRIFF AUF DIE BEFESTIGUNG • TOEGANG TOT HET MONTUUR •  
 VALVE CARTRIDGE ACCESS • ACCESSO A LA MONTATURA • SNADNÝ PŘÍSTUP K MONTÁŽI • ACESSO À ARMAÇÃO •  
 DOSTĘP DO ELEMENTÓW MONTAŻOWYCH • Доступ к кран-буксе

1

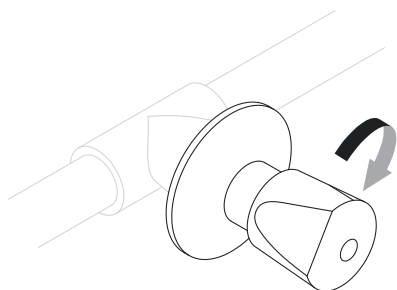

2

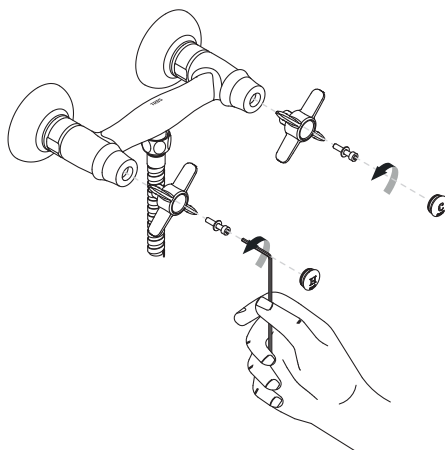
 2.5

3

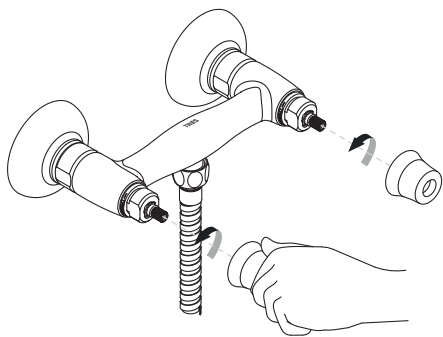

4

18

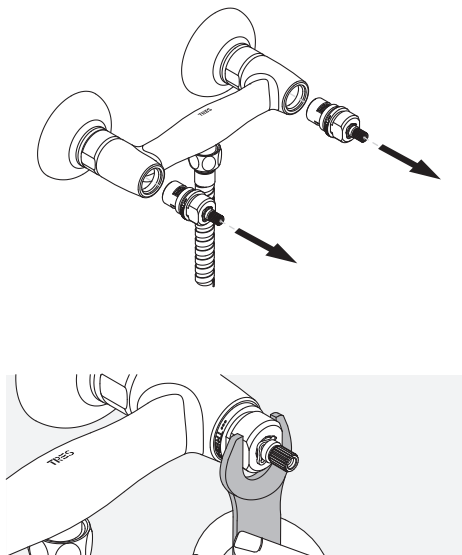

LIMPIEZA • NETTOYAGE • REINIGUNG • REINIGING • PULIZIA • ČIŠTĚNÍ  
CLEANING • CZYSZCZENIE • LIMPEZA • ЧИСТКА

